

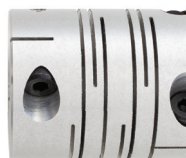

Highlights

Couplings

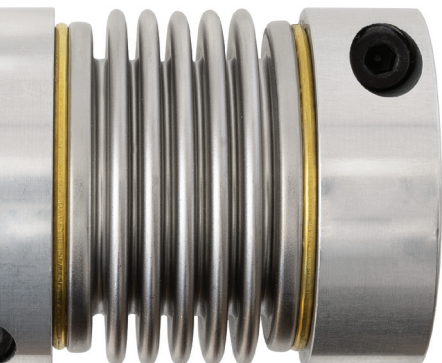

Standard Parts. **Ganter.**

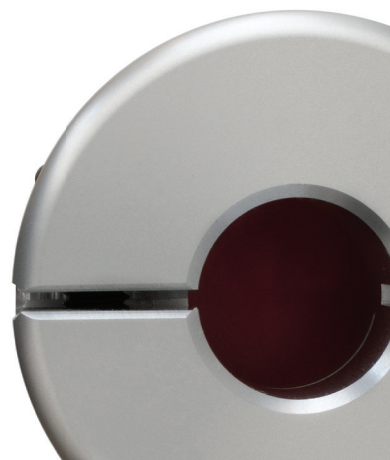

Contents

Couplings

Product index	→ Page	2
General notes	→ Page	4
Overview of types	→ Page	6
<hr/>		
Elastomer jaw couplings GN 2240	→ Page	8
Elastomer jaw couplings GN 2241	→ Page	10
Oldham couplings GN 2242	→ Page	12
Oldham couplings GN 2243	→ Page	14
Bellows couplings GN 2244	→ Page	16
Beam couplings GN 2246	→ Page	18
Coupling spiders GN 2240.1	→ Page	20
<hr/>		
Application examples	→ Page	21
Assembly instructions	→ Page	22
Technical information / Definition of terms	→ Page	24

With the publication of this catalogue, all previous issues become invalid. Technical details are subject to change without notice. The details given herein comply with state of the art engineering at the time of printing. We reserve the right to amend errors and to remove individual articles from the product assortment. The products listed in this catalogue have been developed as standard products with the aim of covering the widest possible spectrum of requirements. We cannot be held liable and responsible for special applications involving extraordinary or unusual uses or requirements concerning our products. Our design department will be pleased to answer questions on certain product properties such as missing tolerance, dimensional details or strength classes. All rights in the catalogue are held by Otto Ganter GmbH & Co. KG. Reprints, also in extracts, are not permitted.

Couplings



GN 2240
Elastomer
jaw couplings
with clamping hub
Aluminum
Page 8



GN 2241
Elastomer
jaw couplings
with grub screw
Aluminum
Page 10



GN 2242
Oldham couplings
with clamping hub
Aluminum
Page 12



GN 2243
Oldham couplings
with grub screw
Aluminum
Page 14



GN 2244
Bellows couplings
with clamping hub
Aluminum
Page 16



GN 2246
Beam couplings
with clamping hub
Aluminum
Page 18



GN 2246
Stainless Steel-
Beam couplings
with clamping hub
Page 18

Accessory



GN 2240.1
Coupling spiders
for GN 2240 / GN 2241
Elastomer
Page 20



Introduction

Couplings create connections between drive shafts and driven shafts in order to transmit rotary motion and torque. For example, they are used to combine the shafts of motors and transmissions into a single drive unit.

Alongside the primary purpose of transmitting torque, couplings also carry out other important tasks:

- Compensating for shaft offsets and misalignments
- Absorbing runout errors and axial motions
- Damping vibrations and shocks

Couplings are used in a very wide range of applications. The spectrum ranges from simple drives to complex control, regulation and measurement applications.

Misalignment and runout tolerances

Like all mechanical parts, shafts are subjected to manufacturing and assembly tolerances that generally cannot be entirely eliminated even with extensive technical measures.

If these deviations are not taken into account in the design, the result can be vibrations, running noises, and wear or damage to the shafts and their bearings.

Suitable couplings not only are able to effectively compensate for misalignment and runout errors, they also greatly simplify the assembly process, thereby reducing the overall labor required.

Shaft misalignment and runout errors can vary in nature and should always be taken into consideration when selecting the appropriate coupling.

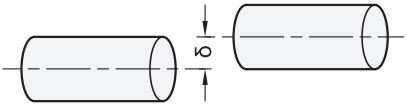
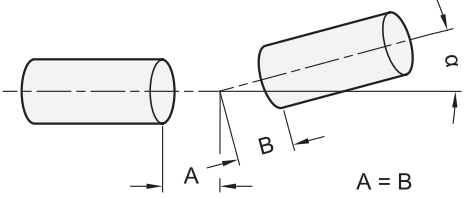
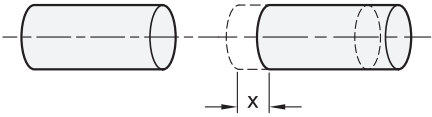
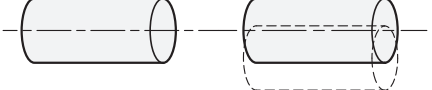
Error type	Misalignment diagram
<p>Lateral</p> <p>The axes of the shafts are in fact parallel, but they are offset laterally and do not line up.</p>	
<p>Angular</p> <p>The axes of the shafts do not lie in the same plane; they meet at a certain angle.</p>	
<p>Axial</p> <p>The shafts move axially along the axis of rotation.</p>	
<p>Runout</p> <p>The shafts move radially out of the center of the axis of rotation.</p>	

Areas of application - Classes - Coupling types

The applications of couplings can generally be divided into two classes.

Motion control

For motion control applications, the rotational movement is transmitted with very high precision and accuracy. This requires a coupling type with a high torsional stiffness and zero backlash in the direction of rotation.

Typical applications are:

Servo or stepper motors for linear axes, industrial robots, test benches, etc.

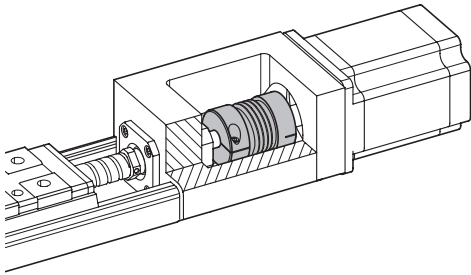

Torque and power transmission

For torque and power transmission, the focus lies on pure transmission of force. This requires couplings that can withstand high torques and heavy loads while functioning reliably in harsh conditions.

Typical applications are:

Conveyor systems, pumps and agitators, packaging machines, etc.

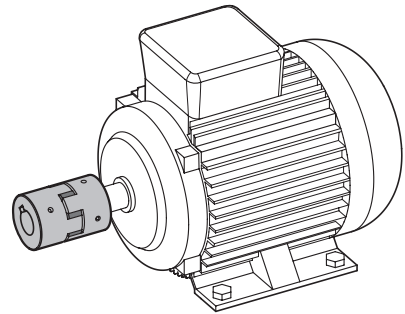

Two coupling types are available for each of the application classes described above.

Bellows couplings and beam couplings

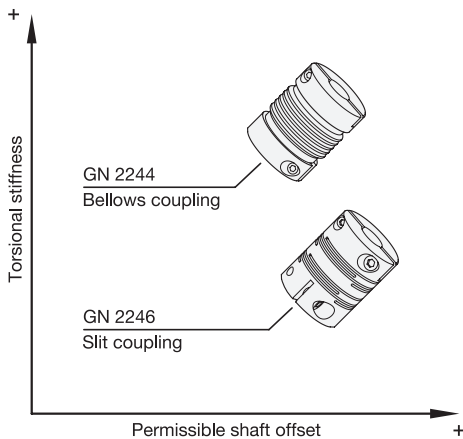

Bellows couplings offer high torsional stiffness. This makes them excellent for precise and controlled movements.





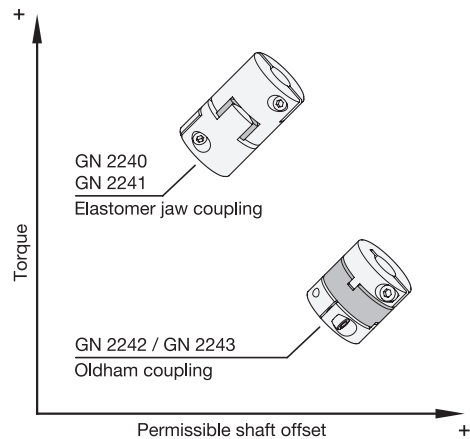



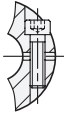

Beam couplings have lower torsional stiffness compared with bellows couplings, but they can compensate for higher shaft misalignments.

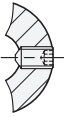
Elastomer jaw couplings and oldham couplings

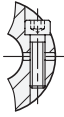

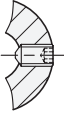
Elastomer jaw couplings are designed for high torque transmission and can be used in all manner of applications.

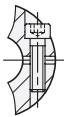
Oldham couplings transmit less torque but can compensate for higher shaft misalignments.

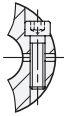
Standard	Shaft Ø in mm	Hub clamping	Rated torque in Nm	Misalignment			Zero backlash	
				axial	lateral	angular		
GN 2240 Page 8 Elastomer jaw couplings		3 - 25		0,7 - 60	x	x	x	
GN 2241 Page 10 Elastomer jaw couplings		3 - 25		0,7 - 60	x	x	x	
GN 2242 Page 12 Oldham couplings		4 - 20		1 - 28		x	x	
GN 2243 Page 14 Oldham couplings		2 - 20		0,5 - 28		x	x	
GN 2244 Page 16 Bellows couplings		5 - 19		1,5 - 10	x	x	x	x
GN 2246 Page 18 Beam couplings		4 - 12		0,3 - 4	x	x	x	x

Standard	Suitable for use with			Application examples	Special features
	Servo motors	Stepper motors	Universal motors		
GN 2240 Page 8 Elastomer jaw couplings	x	x	x	<ul style="list-style-type: none"> - Hydraulic pumps - Packaging machines - Industrial robots - Fans - Agitators 	<ul style="list-style-type: none"> - High torques - Fast and simple plug-in assembly
GN 2241 Page 10 Elastomer jaw couplings	x	x	x		
GN 2242 Page 12 Oldham couplings		x	x	<ul style="list-style-type: none"> - Conveyor systems - Packaging machines - Positioning drives - Pumps 	<ul style="list-style-type: none"> - High torques - High lateral misalignment compensation - Fast and simple plug-in assembly
GN 2243 Page 14 Oldham couplings		x	x		
GN 2244 Page 16 Bellows couplings	x	x		<ul style="list-style-type: none"> - Rotary encoders - Position measuring systems - Test benches - Industrial robots - Spindle drives 	<ul style="list-style-type: none"> - Precise angle and torque transmission - High torsional stiffness
GN 2246 Page 18 Beam couplings		x		<ul style="list-style-type: none"> - Confectionery machines - Industrial robots - CAT scanners - Position measuring systems 	<ul style="list-style-type: none"> - Precise angle and torque transmission - Manufactured from a single piece - High torsional stiffness

$d_1 = 14...30$

Coupling spider



2 Bore code

- B** without keyway
- K** with keyway (from $d_1 = 30$)

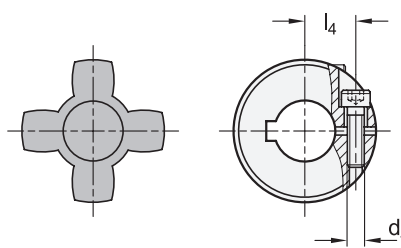
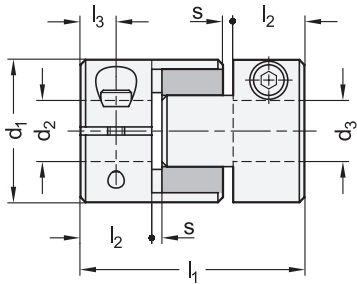

$d_1 = 40$

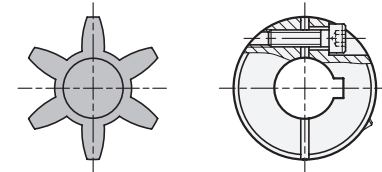
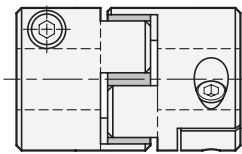

$d_1 = 55$

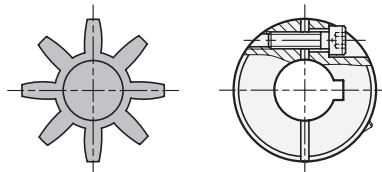
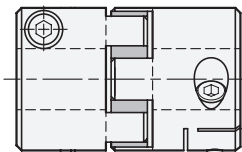

Assembly instruction

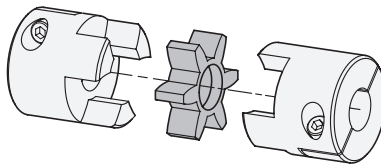

1

3

d_1	$d_2 - d_3$ H8 recommended shaft tolerance h7									
14	3-3	3-4	3-5	3-6	4-4	4-5	4-6	5-5	5-6	6-6
20	5-5	5-6	5-8	6-6	6-8	8-8	-	-	-	-
30	8-8	8-10	8-12	8-14	10-10	10-12	10-14	12-12	12-14	14-14
40	12-12	12-14	12-15	12-16	14-14	14-15	14-16	15-15	15-16	16-16
55	18-18	18-19	18-20	18-25	19-19	19-20	19-25	20-20	20-25	25-25

d_1	d_4	l_1	l_2 recommended shaft insertion depth	l_3	l_4	s recommended installation spacing
14	M 2 / M 1,6*	22	7	3,5	4 / 5*	1
20	M 2,5	30	10	5	6,5	1
30	M 4 / M 3**	35	11	5,5	10 / 11**	1,5
40	M 5	66	25	8,5	14	2
55	M 6	78	30	10,5	20	2

* for bore $d_2 / d_3 = 6$ ** for bore $d_2 / d_3 = 14$

d ₁	Coupling spider	Shore hardness coupling spider	Rated torque in Nm	Max. torque in Nm	Max. speed (min ⁻¹)	Moment of inertia in kgm ²	Static torsional stiffness in Nm/rad	Max. shaft misalignment		
								lateral in mm	axial in mm	angular in °
14	BS	80A	0,7	1,4	45.000	2,0 x 10 ⁻⁷	8	0,15	0,6	1
	WS	92A	1,2	2,4	45.000	2,0 x 10 ⁻⁷	14	0,1	0,6	1
	RS	98A	2	4	45.000	2,0 x 10 ⁻⁷	22	0,1	0,6	1
20	BS	80A	1,8	3,6	31.000	1,1 x 10 ⁻⁶	16	0,2	0,8	1
	WS	92A	3	6	31.000	1,1 x 10 ⁻⁶	29	0,15	0,8	1
	RS	98A	5	10	31.000	1,1 x 10 ⁻⁶	55	0,1	0,8	1
30	BS	80A	4	8	21.000	6,2 x 10 ⁻⁶	46	0,2	1	1
	WS	92A	7,5	15	21.000	6,2 x 10 ⁻⁶	73	0,15	1	1
	RS	98A	12,5	25	21.000	6,2 x 10 ⁻⁶	130	0,1	1	1
40	BS	80A	4,9	9,8	15.000	3,7 x 10 ⁻⁵	380	0,15	1,2	1
	WS	92A	10	20	15.000	3,7 x 10 ⁻⁵	570	0,1	1,2	1
	RS	98A	17	34	15.000	3,7 x 10 ⁻⁵	1200	0,1	1,2	1
55	BS	80A	17	34	11.000	1,6 x 10 ⁻⁴	1400	0,2	1,4	1
	WS	92A	35	70	11.000	1,6 x 10 ⁻⁴	1600	0,15	1,4	1
	RS	98A	60	120	11.000	1,6 x 10 ⁻⁴	2600	0,1	1,4	1

Specification



- Hub
Aluminum **AL**
anodized, natural color
- Coupling spider
Polyurethane (TPU)
temperature resistant up to 60 °C
Hardness
80 Shore A, blue **BS**
92 Shore A, white **WS**
98 Shore A, red **RS**
- Socket cap screws DIN 912
Steel, blackened
- Temperature range: -20 °C up to +60 °C
- Keyway P9 DIN 6885
→ Main Catalogue Page 1420
- ISO-Fundamental tolerances
→ Main Catalogue Page 1479
- Elastomer characteristics
→ Main Catalogue Page 1483
- RoHS

Accessory

- Coupling spiders GN 2240.1 → Page 20

Information

Elastomer jaw couplings GN 2240 can transmit very high torques while compensating for shaft misalignments and runout tolerances. They are preferred in applications where the focus lies on pure torque and power transmission.

The choice of three coupling spiders with different hardness values allows the properties of the coupling to be optimally matched to the specific requirements. The clamping hubs and simple plug-in installation make jaw couplings very easy to assemble.

With the bore code K, the keyway is always integrated into both bores d₂ and d₃.

see also...

- [Assembly instructions on couplings](#) → Page 22
- [Technical information on couplings](#) → Page 24
- [Elastomer jaw couplings GN 2241 \(with grub screw\)](#) → Page 10
- [Oldham couplings GN 2242 \(with clamping hub\)](#) → Page 12

How to order

1	d ₁
2	Bore code
3	d ₂ - d ₃
4	Material
5	Hardness



GN 2240-40-B12-16-AL-RS

$d_1 = 14...30$

Coupling spider

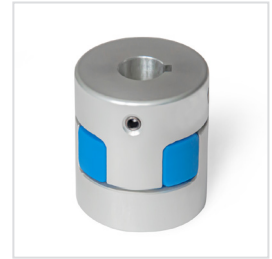

2 Bore code

B without keyway

K with keyway
(from $d_1 = 30$)

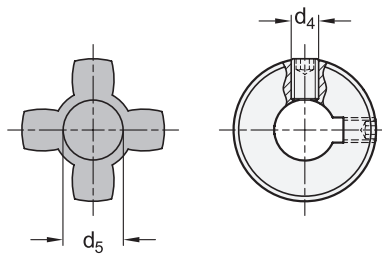
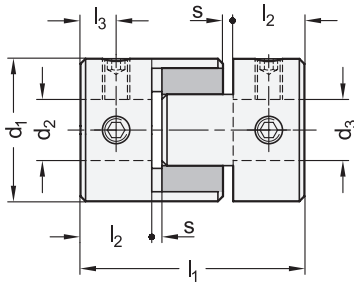

$d_1 = 40$

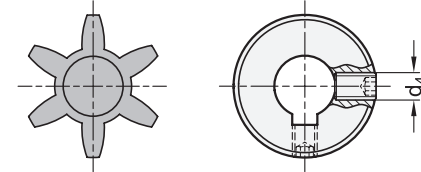
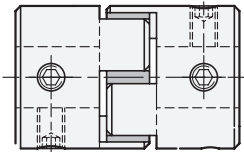

$d_1 = 55$

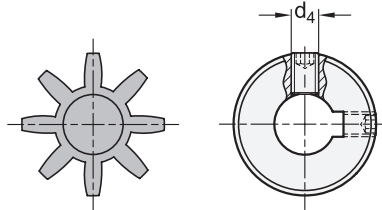
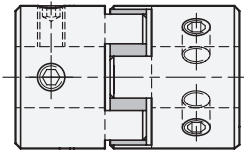

Assembly instruction

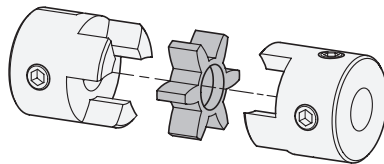

1

3

d_1	$d_2 - d_3$ H8 recommended shaft tolerance h7									
14	3-3	3-4	3-5	3-6	4-4	4-5	4-6	5-5	5-6	6-6
20	5-5	5-6	5-8	6-6	6-8	8-8	-	-	-	-
30	8-8	8-10	8-12	8-14	10-10	10-12	10-14	12-12	12-14	14-14
40	12-12	12-14	12-15	12-16	14-14	14-15	14-16	15-15	15-16	16-16
55	18-18	18-19	18-20	18-25	19-19	19-20	19-25	20-20	20-25	25-25

d_1	d_4	l_1	l_2 recommended shaft insertion depth	l_3	s recommended installation spacing	Tightening torque of the screw in Nm \approx
14	M 3	22	7	3,5	1	0,7
20	M 3	30	10	5	1	0,7
30	M 4	35	11	5,5	1,5	1,7
40	M 5	66	25	8,5	2	4
55	M 6	78	30	10,5	2	7

d ₁	Coupling spider	Shore hardness coupling spider	Rated torque in Nm	Max. torque in Nm	Max. speed (min ⁻¹)	Moment of inertia in kgm ²	Static torsional stiffness in Nm/rad	Max. shaft misalignment		
								lateral in mm	axial in mm	angular in °
14	BS	80A	0,7	1,4	45.000	2,0 × 10 ⁻⁷	8	0,15	0,6	1
	WS	92A	1,2	2,4	45.000	2,0 × 10 ⁻⁷	14	0,1	0,6	1
	RS	98A	2	4	45.000	2,0 × 10 ⁻⁷	22	0,1	0,6	1
20	BS	80A	1,8	3,6	31.000	1,1 × 10 ⁻⁶	16	0,2	0,8	1
	WS	92A	3	6	31.000	1,1 × 10 ⁻⁶	29	0,15	0,8	1
	RS	98A	5	10	31.000	1,1 × 10 ⁻⁶	55	0,1	0,8	1
30	BS	80A	4	8	21.000	6,2 × 10 ⁻⁶	46	0,2	1	1
	WS	92A	7,5	15	21.000	6,2 × 10 ⁻⁶	73	0,15	1	1
	RS	98A	12,5	25	21.000	6,2 × 10 ⁻⁶	130	0,1	1	1
40	BS	80A	4,9	9,8	15.000	3,7 × 10 ⁻⁵	380	0,15	1,2	1
	WS	92A	10	20	15.000	3,7 × 10 ⁻⁵	570	0,1	1,2	1
	RS	98A	17	34	15.000	3,7 × 10 ⁻⁵	1200	0,1	1,2	1
55	BS	80A	17	34	11.000	1,6 × 10 ⁻⁴	1400	0,2	1,4	1
	WS	92A	35	70	11.000	1,6 × 10 ⁻⁴	1600	0,15	1,4	1
	RS	98A	60	120	11.000	1,6 × 10 ⁻⁴	2600	0,1	1,4	1

Specification



- Hub
Aluminum
anodized, natural color **AL**
- Coupling spider
Polyurethane (TPU)
temperature resistant up to 60 °C
Hardness
80 Shore A, blue **BS**
92 Shore A, white **WS**
98 Shore A, red **RS**
- Grub screws
- Steel, blackened
- for d₂ / d₃ ≤ 4, one grub screw
- for d₂ / d₃ > 4, two grub screws
- Temperature range: -20 °C up to +60 °C
- Keyway P9 DIN 6885
→ Main Catalogue Page 1420
- ISO-Fundamental tolerances
→ Main Catalogue Page 1479
- Elastomer characteristics
→ Main Catalogue Page 1483
- RoHS

Accessory

- Coupling spiders GN 2240.1 → Page 20

Information

Elastomer jaw couplings GN 2240 can transmit very high torques while compensating for shaft misalignments and runout tolerances. They are preferred in applications where the focus lies on pure torque and power transmission.

The choice of three coupling spiders with different hardness values allows the properties of the coupling to be optimally matched to the specific requirements. The use of grub screws for clamping and the simple plug-in installation make jaw couplings very easy to assemble.

With the bore code K, the keyway is always integrated into both bores d₂ and d₃.

see also...

- *Assembly instructions on couplings* → Page 22
- *Technical information on couplings* → Page 24
- *Elastomer jaw couplings GN 2240 (with clamping hub)* → Page 8
- *Oldham couplings GN 2243 (with grub screw)* → Page 14

How to order

1	d ₁
2	Bore code
3	d ₂ - d ₃
4	Material
5	Hardness



GN 2241-30-B10-10-AL-BS

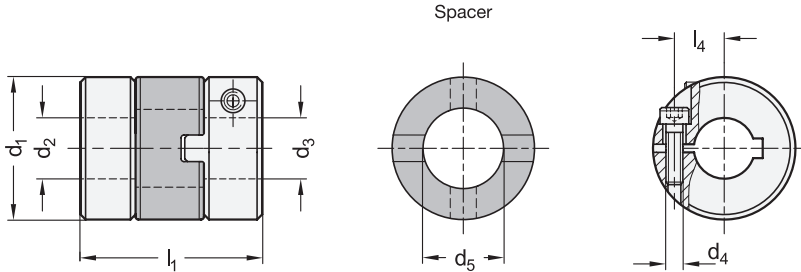

2 Bore code

- B** without keyway
- K** with keyway (from $d_1 = 20$)

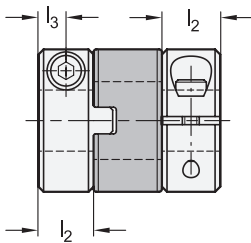

Assembly instruction

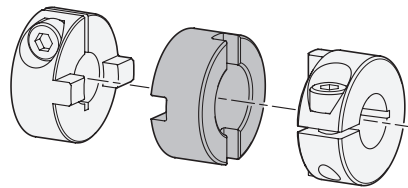

1

3

d_1	$d_2 - d_3$ H8 recommended shaft tolerance h7					
12	4-4	4-5	5-5	-	-	-
15	4-4	4-5	4-6	5-5	5-6	6-6
20	6-6	6-8	6-10	8-8	8-10	10-10
30	8-8	8-10	8-12	10-10	10-12	12-12
38	12-12	12-15	12-20	15-15	15-20	20-20

d_1	d_4	d_5	l_1	l_2 recommended shaft insertion depth	l_3	l_4
12	M 2	5,2	19	6,2	3,1	4
15	M 2,5	8,2	21,2	7	3,5	5
20	M 3	12,2	27	8,8	4,4	7,5
30	M 4	16,2	32,5	10	5	11,1
38	M 5	20,3	40	12,1	6	14,2

d_1	Rated torque in Nm	Max. torque in Nm	Max. speed (min ⁻¹)	Moment of inertia in kgm ²	Static torsional stiffness in Nm/rad	Max. shaft misalignment	
						lateral in mm	angular in °
12	1	2	52.000	$6,6 \times 10^{-8}$	60	1	3
15	1,6	3,2	42.000	$1,7 \times 10^{-7}$	80	1	3
20	3,2	6,4	31.000	$8,0 \times 10^{-7}$	120	1,2	3
30	15	30	21.000	$5,3 \times 10^{-6}$	530	2	3
38	28	56	16.000	$1,5 \times 10^{-5}$	1500	2,5	3

*Load fluctuations are not taken into account



Specification

- Hub
Aluminum
anodized, natural color **AL**
- Spacer
Technopolymer (Polyacetal POM)
temperature resistant up to 80 °C **KU**
- Socket cap screws DIN 912
Steel, blackened
- Temperature range: -20 °C up to +80 °C
- Keyway P9 DIN 6885
→ Main Catalogue Page 1420
- ISO-Fundamental tolerances
→ Main Catalogue Page 1479
- Plastic characteristics
→ Main Catalogue Page 1483
- RoHS

4 5

Information

Oldham couplings GN 2242 can compensate for large lateral shaft misalignments while transmitting high torques. As a result, they are used in applications with a focus on pure torque and power transmission associated with high lateral shaft misalignments.

The clamping hubs and simple plug-in installation make oldham couplings very easy to assemble. They are suitable for a diverse range of applications and are used in general machine construction in packaging machines and pumps.

With the bore code K, the keyway is always integrated into both bores d_2 and d_3 .

see also...

- Assembly instructions on couplings → Page 22
- Technical information on couplings → Page 24
- Oldham couplings GN 2243 (with grub screw) → Page 14
- Elastomer jaw couplings GN 2240 (with clamping hub) → Page 8

How to order

1	d_1
2	Bore code
3	$d_2 - d_3$
4	Material (Hub)
5	Material (Spacer)

1 2 3 4 5
GN 2242-20-B 8-10-AL-KU

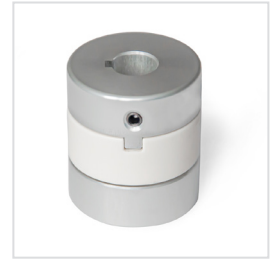
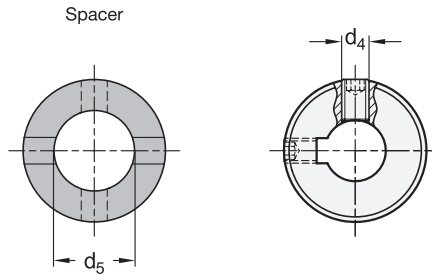
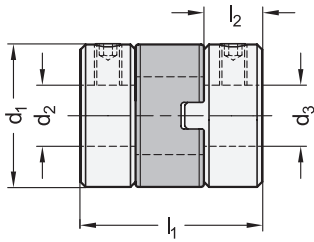

2 Bore code

- B** without keyway
- K** with keyway (from $d_1 = 20$)

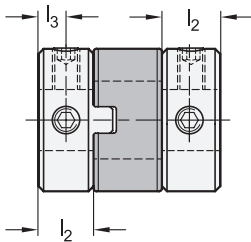

Assembly instruction

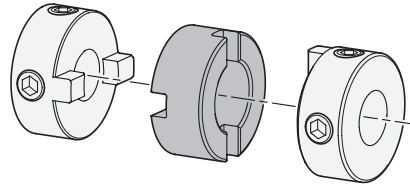

1

3

d_1	$d_2 - d_3$ H8 recommended shaft tolerance h7					
8	2-2	2-3	3-3	-	-	-
12	4-4	4-5	5-5	-	-	-
15	4-4	4-5	4-6	5-5	5-6	6-6
20	6-6	6-8	6-10	8-8	8-10	10-10
30	8-8	8-10	8-12	10-10	10-12	12-12
38	12-12	12-15	12-20	15-15	15-20	20-20

d_1	d_4	d_5	l_1	l_2 recommended shaft insertion depth	l_3	Tightening torque of the screw in Nm \approx
8	M 2	3,1	9,6	2,5	1,3	0,3
12	M 3	5,2	14,2	3,9	2	0,7
15	M 3	8,2	16	4,4	2,2	0,7
20	M 4	12,2	21,4	5,8	2,9	1,7
30	M 4	16,2	32,5	10	5	1,7
38	M 5	20,3	40	12,1	6,1	4

d_1	Rated torque in Nm	Max. torque in Nm	Max. speed (min ⁻¹)	Moment of inertia in kgm ²	Static torsional stiffness in Nm/rad	Max. shaft misalignment lateral in mm	angular in °
8	0,5	1	78.000	$7,4 \times 10^{-9}$	12	0,7	3
12	1	2	52.000	$5,3 \times 10^{-8}$	60	1	3
15	1,6	3,2	42.000	$1,4 \times 10^{-7}$	80	1	3
20	3,2	6,4	31.000	$5,7 \times 10^{-7}$	120	1,2	3
30	15	30	21.000	$5,4 \times 10^{-6}$	530	2	3
38	28	56	16.000	$1,6 \times 10^{-5}$	1500	2,5	3

*Load fluctuations are not taken into account



Specification

- Hub
Aluminum
anodized, natural color **AL**

- Spacer
Technopolymer (Polyacetal POM)
temperature resistant up to 80 °C **KU**

- Grub screws
- Steel, blackened
- for $d_2 / d_3 \leq 4$, one grub screw
- for $d_2 / d_3 > 4$, two grub screws

- Temperature range: -20 °C up to +80 °C

- Keyway P9 DIN 6885
→ Main Catalogue Page 1420

- ISO-Fundamental tolerances
→ Main Catalogue Page 1479

- Plastic characteristics
→ Main Catalogue Page 1483

- RoHS

Information

Oldham couplings GN 2243 can compensate for large lateral shaft misalignments while transmitting high torques. As a result, they are used in applications with a focus on pure torque and power transmission associated with high lateral shaft misalignments.

The use of grub screws for clamping and the simple plug-in installation make oldham couplings very easy to assemble. They are suitable for a diverse range of applications and are used in general machine construction in packaging machines and pumps.

With the bore code K, the keyway is always integrated into both bores d_2 and d_3 .

see also...

- [Assembly instructions on couplings](#) → Page 22
- [Technical information on couplings](#) → Page 24
- [Oldham couplings GN 2242 \(with clamping hub\)](#) → Page 12
- [Elastomer jaw couplings GN 2241 \(with grub screw\)](#) → Page 10

How to order

1	d_1
2	Bore code
3	$d_2 - d_3$
4	Material (Hub)
5	Material (Spacer)

GN 2243-38-K15-20-AL-KU



2 Bore code
B without keyway

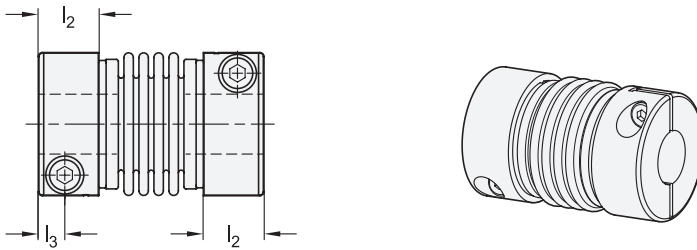
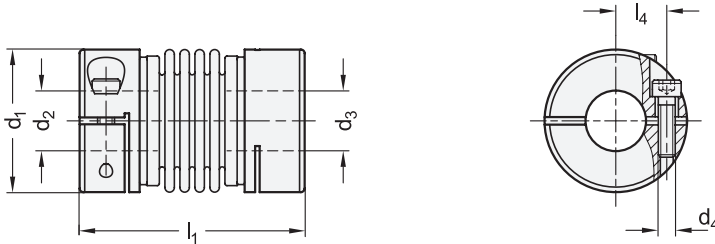

d₁	d₂ - d₃ H8 recommended shaft tolerance h7					
	19	5-5	5-6	5-8	6-6	6-8
27	6-6	6-8	6-10	8-8	8-10	10-10
32	10-10	10-12	10-14	12-12	12-14	14-14
40	12-12	12-15	12-19	15-15	15-19	19-19

d₁	d₄	l₁	l₂ recommended shaft insertion depth	l₃	l₄	Tightening torque of the screw in Nm ≈
19	M 2	30	10,5	3	6,8	0,5
27	M 2,5	35	12,5	3,5	10,3	0,9
32	M 3	46	15,5	4,3	12	1,5
40	M 4	51	16	5	15	3,5

d₁	Rated torque in Nm	Max. speed (min ⁻¹)	Moment of inertia in kgm ²	Static torsional stiffness in Nm/rad	Max. shaft misalignment		
					lateral in mm	axial in mm	angular in °
19	1,5	33.000	8,6 × 10 ⁻⁷	170	0,15	± 0,5	1,5
27	2,3	23.000	3,6 × 10 ⁻⁶	800	0,15	± 0,5	1,5
32	4,5	19.000	1,1 × 10 ⁻⁵	1600	0,2	± 0,7	1,5
40	10	15.000	2,8 × 10 ⁻⁵	2700	0,2	± 1	1,5



Specification

- Hub
Aluminum anodized, natural color **AL**

- Bellows
Stainless Steel AISI 304 **NI**

- Socket cap screws DIN 912
Steel, blackened

- temperature resistant up to 120 °C

- ISO-Fundamental tolerances
→ Main Catalogue Page 1479

- Stainless Steel characteristics
→ Main Catalogue Page 1489

- RoHS

On request

- Bore with keyway

Information

Bellows couplings GN 2244 transmit angle positions and torques with extreme precision and zero backlash. The metal bellows also reliably compensates for shaft misalignments and runout tolerances. The clamping hubs make bellows couplings very easy to install.

They are used in applications where precise position and movement transmission is required, such as in the servo drive systems of machine tools and in industrial robots.

see also...

- [Assembly instructions on couplings](#) → Page 22
- [Technical information on couplings](#) → Page 24
- [Beam couplings GN 2246](#) → Page 18
- [Elastomer jaw couplings GN 2240 \(with clamping hub\)](#) → Page 8

How to order

1	d ₁
2	Bore code
3	d ₂ - d ₃
4	Material (Hub)
5	Material (Bellows)

GN 2244-40-B12-19-AL-NI

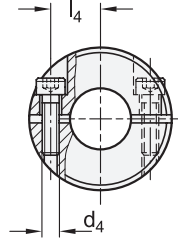
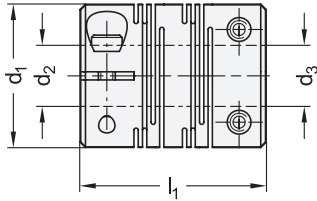

ROESTSTAHL® Rost freit
Inox
Stainless
Steel

2 Bore code

B without keyway

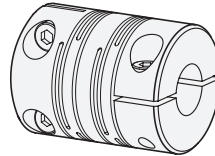
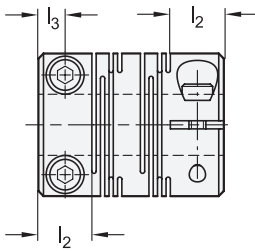

1

3

d₁	d₂ - d₃ H8 recommended shaft tolerance h7					
12	4-4	4-5	5-5	-	-	-
16	5-5	5-6	6-6	-	-	-
20	5-5	5-6	5-8	6-6	6-8	8-8
25	6-6	6-8	6-10	8-8	8-10	10-10
32	10-10	10-12	12-12	-	-	-

d₁	d₄	l₁	l₂ recommended shaft insertion depth	l₃	l₄	Tightening torque of the screw in Nm ≈
12	M 2	18,5	5	2,5	4	0,5
16	M 2,5	23	6,5	3,25	5	1
20	M 2,5	26	7,5	3,75	6,5	1
25	M 3	31	8,5	4,25	9	1,5
32	M 4	41	12	6	11	2,5

Aluminum							
d ₁	Rated torque in Nm	Max. speed (min ⁻¹)	Moment of inertia in kgm ²	Static torsional stiffness in Nm/rad	Max. shaft misalignment		
					lateral in mm	axial in mm	angular in °
12	0,4	52.000	$7,8 \times 10^{-8}$	45	0,1	± 0,3	2
16	0,5	39.000	$3,4 \times 10^{-7}$	80	0,1	± 0,4	2
20	1	31.000	$9,1 \times 10^{-7}$	170	0,1	± 0,4	2
25	2	25.000	$2,6 \times 10^{-6}$	380	0,15	± 0,5	2
32	4	19.000	$9,7 \times 10^{-6}$	500	0,15	± 0,5	2

Stainless Steel							
d ₁	Rated torque in Nm	Max. speed (min ⁻¹)	Moment of inertia in kgm ²	Static torsional stiffness in Nm/rad	Max. shaft misalignment		
					lateral in mm	axial in mm	angular in °
12	0,3	52.000	$2,2 \times 10^{-7}$	64	0,1	± 0,2	2
16	0,5	39.000	$9,0 \times 10^{-7}$	85	0,1	± 0,3	2
20	1	31.000	$2,5 \times 10^{-6}$	250	0,1	± 0,3	2
25	2	25.000	$7,1 \times 10^{-6}$	330	0,15	± 0,4	2
32	3,5	19.000	$2,7 \times 10^{-5}$	850	0,15	± 0,5	2

Specification

- Aluminum **AL**
 - anodized, natural color
 - temperature resistant up to 150 °C
 - Socket cap screws DIN 912 Steel, blackened
- Stainless Steel **NI**
 - AISI 303
 - temperature resistant up to 200 °C
 - Socket cap screws DIN 912 Stainless Steel AISI 304 Cu
- *ISO-Fundamental tolerances*
→ Main Catalogue Page 1479
- *Stainless Steel characteristics*
→ Main Catalogue Page 1489
- **RoHS**

On request

- Bore with keyway

Information

Beam couplings GN 2246 transmit angle positions and torques with extreme precision and no backlash. They are manufactured of a single piece and offer high torsional stiffness thanks to the alternating slits. The clamping hubs make beam couplings very easy to assemble.

They are used in applications where precise position and movement transmission is required, such as in the drive systems of position measuring systems and in test benches.

The Stainless Steel version can also be used in environments requiring high corrosion resistance, such as in medical technology (CAT scanners) and food-processing equipment (confectionary machines).

see also...

- *Assembly instructions on couplings* → Page 22
- *Technical information on couplings* → Page 24
- *Bellows couplings GN 2244* → Page 16
- *Elastomer jaw couplings GN 2240 (with clamping hub)* → Page 8

How to order

1	d ₁
2	Bore code
3	d ₂ - d ₃
4	Material

GN 2246-32-B 10-12-AL

$d_1 = 14...30$

$d_1 = 40$

$d_1 = 55$

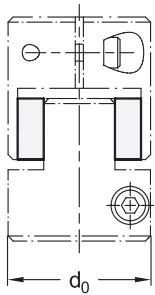
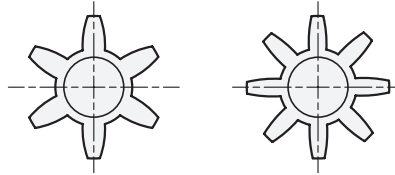
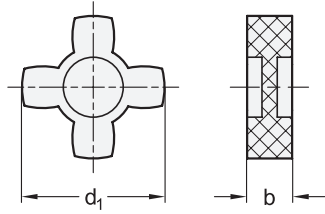

Assembly instruction

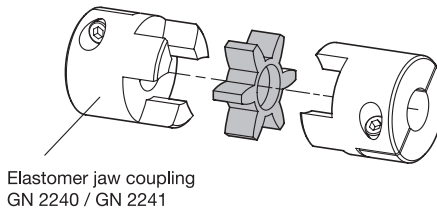

Elastomer jaw coupling
GN 2240 / GN 2241



d_0 Coupling \varnothing GN 2240 / GN 2241	d_1	b	Number of teeth
14	14	6	4
20	20	8	4
30	30	10	4
40	40	12	6
55	55	14	8

Specification

- Polyurethane (TPU)
temperature resistant up to 60 °C
- Hardness
- 80 Shore A, blue
- 92 Shore A, white
- 98 Shore A, red

BS
WS
RS

- *Elastomer characteristics*
→ Main Catalogue Page 1483
- **RoHS**



Information

Coupling spiders GN 2240.1 are intended as replacement parts or for adjusting elastomer jaw couplings GN 2240 / GN 2241.

The choice of three coupling spiders with different hardness values allows the properties of the coupling to be optimally matched to the specific requirements.

see also...

- *Elastomer jaw couplings GN 2241 (clamping hub)* → Page 8
- *Elastomer jaw couplings GN 2241 (with grub screw)* → Page 10

How to order

GN 2240.1-40-RS

1 d_1

2 Hardness

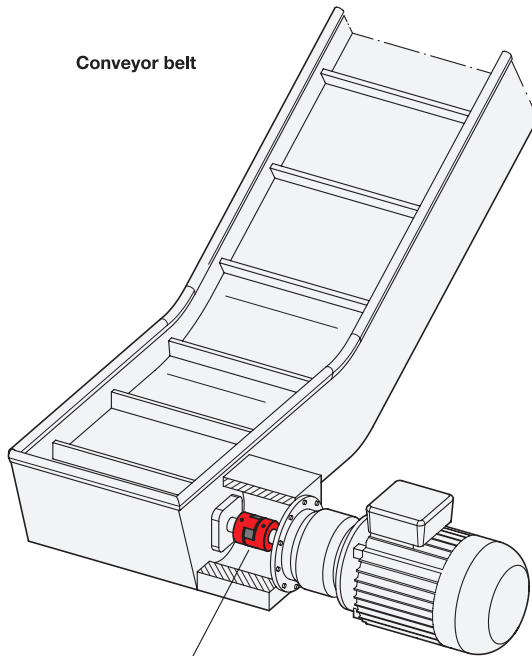

Conveyor belt

Elastomer jaw coupling
GN 2240 / GN 2241

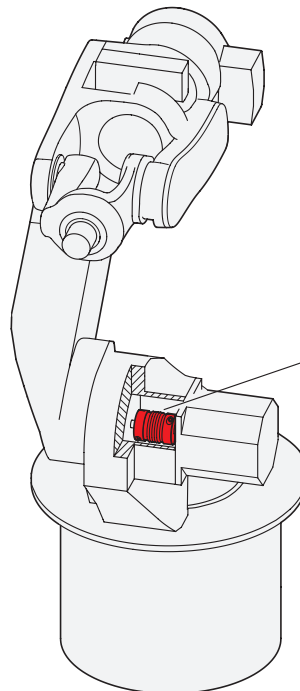

Industrial robot

Bellows coupling
GN 2244

Shaft-hub fastening

The right type of fastening must be selected to ensure simple and reliable mounting of the coupling hub on the shaft. The following shaft-hub fastening types are available:

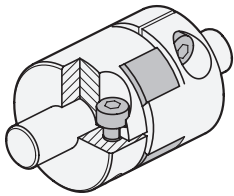
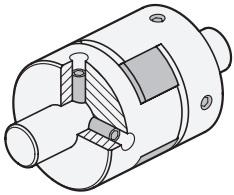
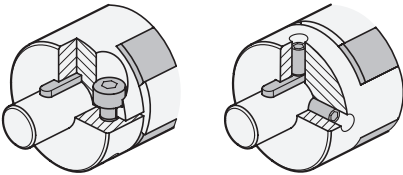
Clamping hub	
	<p>The fastening with clamping hubs is entirely non-positive by reducing the slit height using socket head screws.</p> <p>In this type, the coupling hub is fastened simply and securely with a high clamping force, without damaging the surface of the shafts.</p>
Grub screw	
	<p>When used for fastening, grub screws are inserted radially to create a positive and non-positive connection to the shaft surface.</p> <p>Alignment holes bored into the mounting diameter allow the coupling hub to be positioned precisely. At the same time, this prevents damage to the clamping point.</p>
Combination with keyway	
	<p>The combination of grub screw or clamping hub fastening with feather keys prevents slipping due to torque while ensuring precise angular positioning of the shafts.</p> <p>This type of fastening also provides for maximum torque transmission.</p>

Shaft insertion depth

For correct fastening of the coupling hubs, the shaft must be installed according to the recommended shaft insertion depth l_2 . The shaft insertion depth l_2 is specified in the standard sheet of the respective coupling.

If the insertion depth is too low, the shaft could slip out of the coupling, or the clamping hub could break. If the shaft is inserted too far, this can cause interference within the coupling, leading to damage.

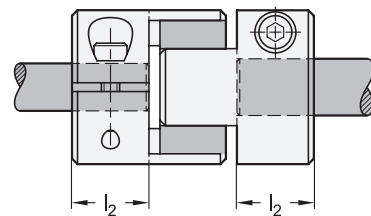

Alignment adjustment

Like all mechanical parts, shafts are subjected to manufacturing and assembly tolerances that generally cannot be entirely eliminated even with extensive technical measures. Couplings can compensate for the resulting misalignments while still ensuring transmission of the necessary torque.

However, if the misalignments exceed the permissible values, this results in vibrations that can quickly shorten the service life of the coupling. The actual shaft misalignment may, therefore, never be larger than the specified permissible values.

The permissible shaft misalignment values given in the standard sheet take into account only the lateral, angular or axial misalignment. In the event of combined misalignments consisting of two or more errors, each permissible value is reduced to half the value specified in the standard sheet.

In general, it is recommended to limit misalignments to no more than one third of the permissible value in the standard sheet. This is because shaft misalignment occurs not only during assembly. It often develops during operation as the result of vibrations, thermal expansion or bearing wear.

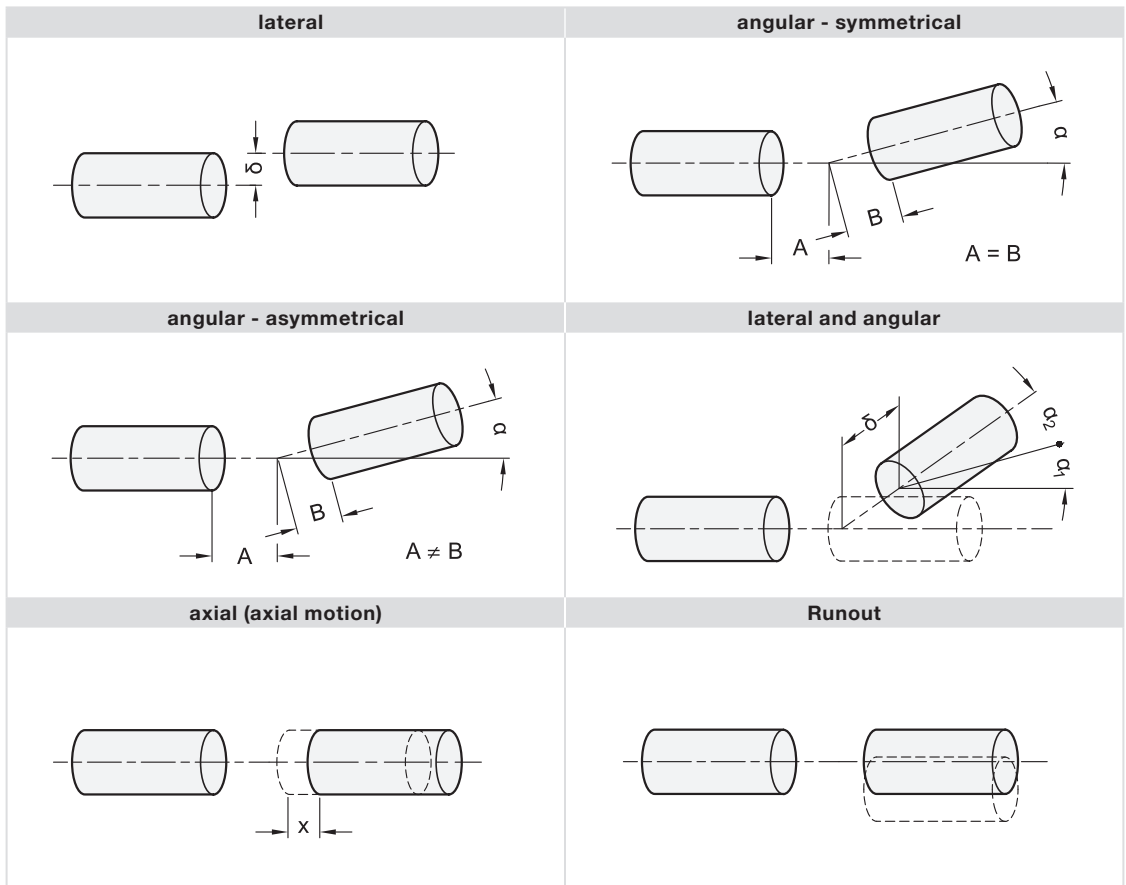

Rated torque

The torque that the coupling can transmit continuously. This value allows for load fluctuations during operation so that rated torque compensation is not required when selecting the couplings (excluding Oldham types). Select a coupling such that the load torque generated during continuous operation does not exceed the rated torque.

Maximum torque

The torque that the coupling can transmit momentarily.

Rotational speed

The maximum rotational speed of the coupling was calculated based on a peripheral speed of 33 m/s. Tests have confirmed that the coupling will not sustain damage at this speed.

Moment of inertia (rotating mass)

This indicates the coupling's resistance to rotation around its own axis. The lower the moment of inertia, the less load torque is required for starting and stopping the motor.

Static torsional stiffness

The static torsional stiffness indicates the number of degrees by which a coupling twists depending on the introduced torque. Torsional stiffness is generally indicated as torque per unit of arc (Nm/rad). To simplify the design process, the torsional stiffness can also be converted to degrees per Nm.

Where:

$$2\pi \text{ rad} = 360^\circ \rightarrow 1 \text{ rad} = \frac{360^\circ}{2\pi} = \frac{180^\circ}{\pi} \approx 57,3^\circ$$

Example:

$$\text{Coupling with a torsional stiffness of } 500 \text{ Nm/rad} = \frac{500 \text{ Nm}}{57,3^\circ} \rightarrow \text{Reciprocal } \frac{57,3^\circ}{500 \text{ Nm}} \approx \frac{0,1146^\circ}{1 \text{ Nm}}$$

Slip torque

Slip torque refers to the torque at which the shaft begins to slip out of the clamping hub. This presumes that the clamping hub was installed at the specified screw tightening torque.

The slip torque values given in the table were derived from experimental testing. They are based on a shaft tolerance of h7, a shaft hardness of 34 to 40 HRC and the screw tightening torque for the clamping hub given in the table.

The load torque must be less than the slip torque for which the coupling is designed. It is also necessary to take into account that the slip torques given in the table are lower than the indicated maximum torque values. If no slip torque is specified, then the maximum torque can be achieved.

Because the slip torque changes due to operating conditions, the suitability of the selected coupling should be tested under real conditions.

GN 2240			
d ₁	d ₂ / d ₃	Slip torque in Nm ≈	Tightening torque of the screw in Nm ≈
14	3	0,8	0,5
14	4	1,4	0,5
14	5	2,1	0,5
14	6	1,3	0,25
20	5	4,9	1
20	6	6,4	1
20	8	9,4	1
30	8	9,3	3,5
30	10	14,6	3,5

GN 2240			
d₁	d₂ / d₃	Slip torque in Nm ≈	Tightening torque of the screw in Nm ≈
30	12	20	3,5
30	14	15,3	1,5
40	12	31,7	8
40	14	38,5	8
40	15	-	8
40	16	-	8
55	18	85	13
55	19	91,5	13
55	20	98	13
55	25	130	13

GN 2242			
d₁	d₂ / d₃	Slip torque in Nm ≈	Tightening torque of the screw in Nm ≈
12	4	1,9	0,5
12	5	2,4	0,5
15	4	2,3	1
15	5	3,5	1
15	6	4,8	1
20	6	4,2	1,5
20	8	5,7	1,5
20	10	-	1,5
30	8	7,5	2,5
30	10	13,9	2,5
30	12	17,2	2,5
38	12	20,2	4
38	15	30	4
38	20	38,8	4

GN 2246			
d₁	d₂ / d₃	Slip torque in Nm ≈	Tightening torque of the screw in Nm ≈
12	4	-	0,5
12	5	-	0,5
16	5	-	1
16	6	-	1
20	5	-	1
20	6	-	1
20	8	-	1
25	6	0,7	1,5
25	8	1,7	1,5
25	10	-	1,5
32	10	2,7	2,5
32	12	-	2,5

Temperature correction factors

If the ambient temperature is greater than 30 °C, the rated torque and the maximum torque must be adjusted using the temperature correction factors.

Ambient temperature	Temperature correction factor	
	for GN 2240 / GN 2241	for GN 2242 / GN 2243
-20 °C up to +30 °C	1	1
+30 °C up to +40 °C	0,8	0,8
+40 °C up to +60 °C	0,7	0,7
+60 °C up to +80 °C	-	0,55

Static torsional stiffness and temperature

The diagrams show the change in static torsional stiffness within the permissible operating temperature range, under the assumption that the static torsional stiffness at 20 °C is 100 percent. The torsional stiffness of the couplings decreases with increasing temperature.

GN 2240 / GN 2241

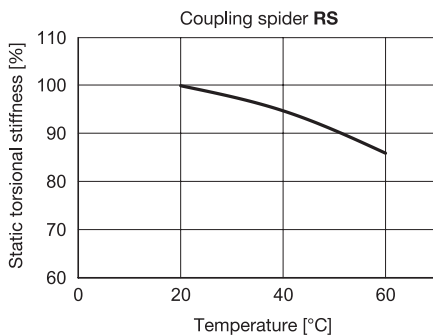
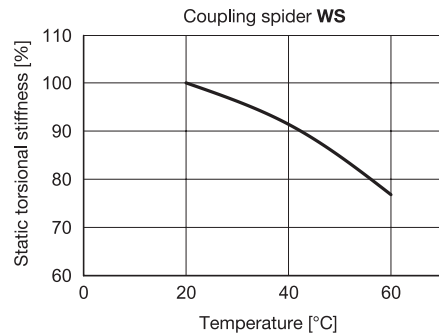
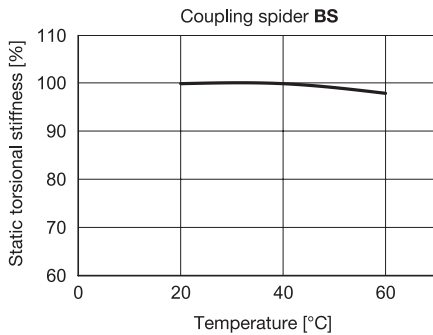

GN 2242 / GN 2243

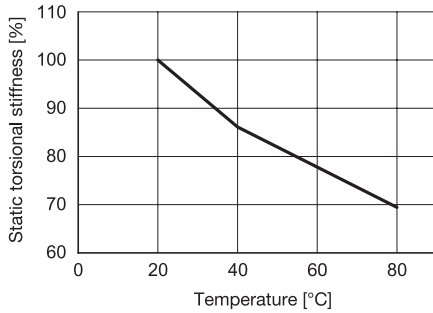

GN 2244

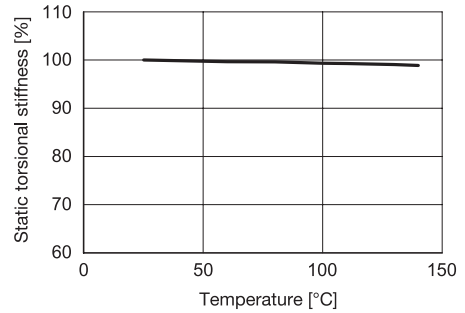

GN 2246

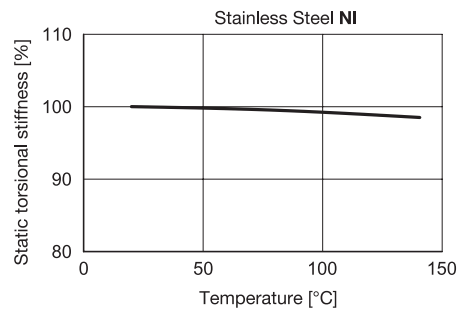
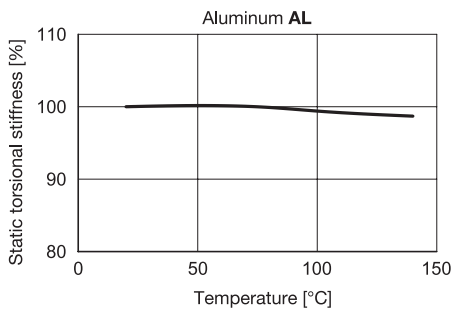

Restoring force – Eccentricity

When the shaft ends are installed in eccentric arrangements, the coupling constantly attempts to return to its neutral position. The resulting force is referred to as restoring force.

If the couplings are installed with the lowest possible eccentricity, the resulting restoring forces are lower. This also reduces the force acting on the shaft bearing.

GN 2240 / GN 2241

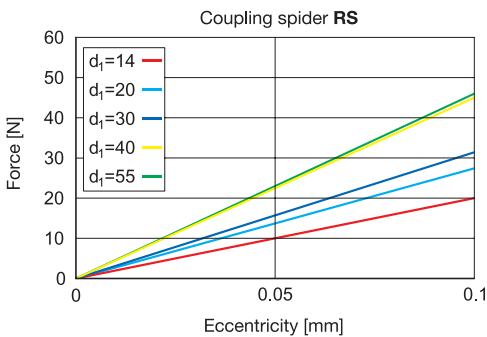
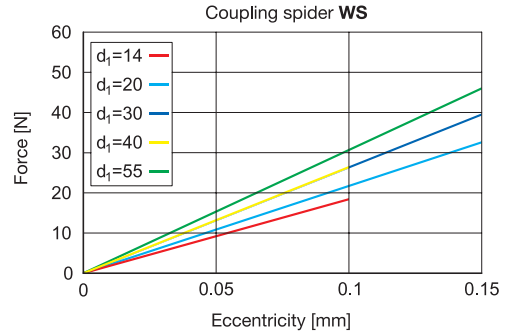
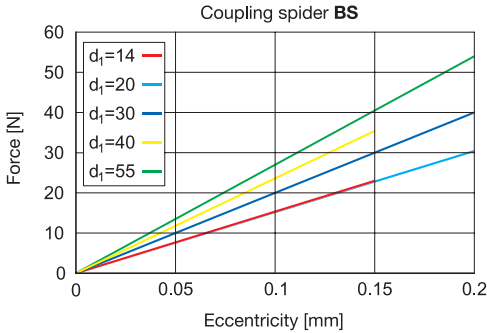

GN 2242 / GN 2243

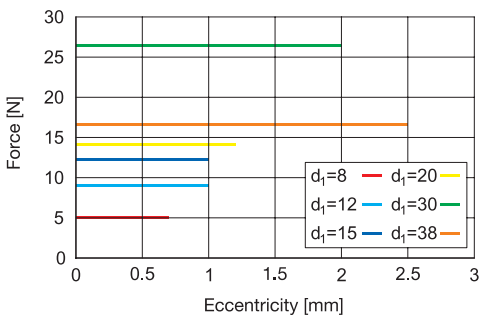

GN 2244

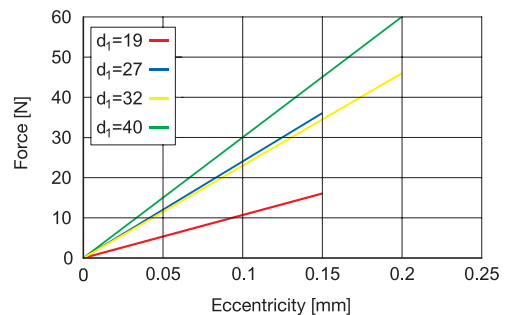

GN 2246

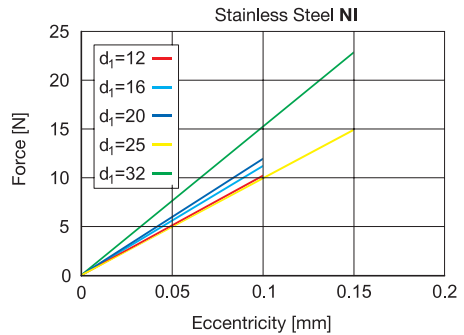
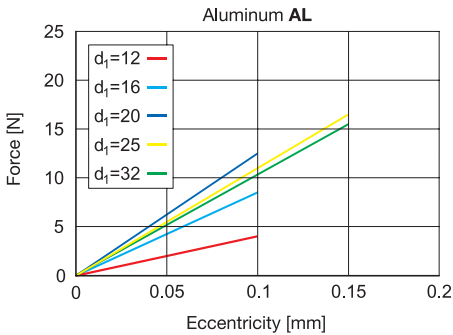

Restoring force – Pressure

If the coupling is under pressure, subject to compressive load in the axial direction, it will strive to return to its neutral position. The force that counteracts the compressive force is referred to as restoring force.

Lowering the compression acting on a coupling results in a lower restoring force and less force exerted axially. This must always be taken into account in dimensioning the coupling.

GN 2244

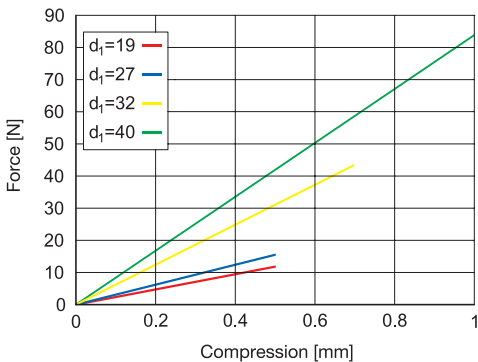

GN 2246

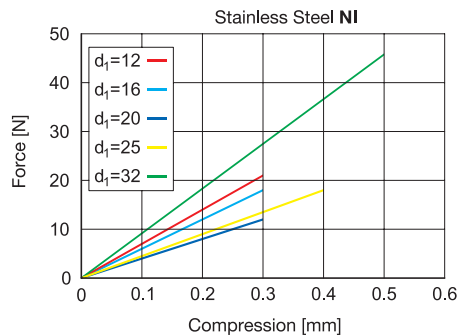
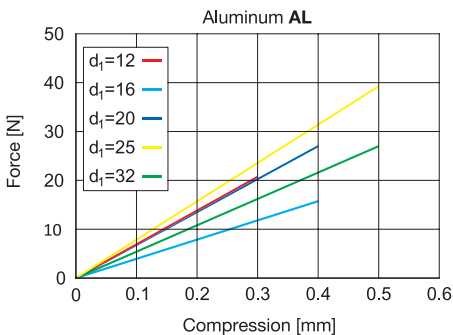

Otto Ganter GmbH & Co. KG

Triberger Straße 3
78120 Furtwangen
Germany

Tel. +49 7723 6507-0

Mail info@ganternorm.com

www.ganternorm.com