

Form V

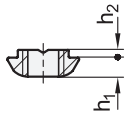

Form F

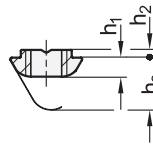

Form S

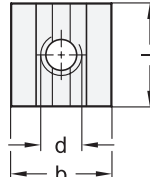
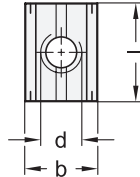
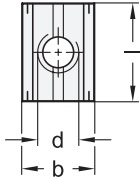
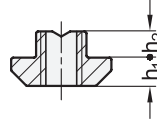

3 Form

- V mit Verdrehsicherung
- F mit Verdrehsicherung, mit Feder
- S schwer

Verwendung

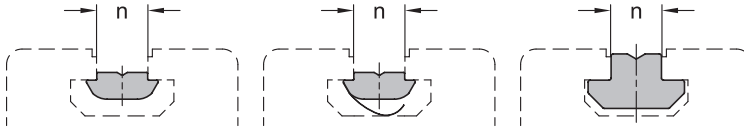

1

2

Form V

n	d				b	h ₁	h ₂	Länge l
8	M 4	M 5	M 6	M 8	11,6	3,8	1	16
10	M 4	M 5	M 6	M 8	14	3,8	1,5	20

1

2

Form F

n	d				b	h ₁	h ₂	h ₃ ≈	Länge l
8	M 4	M 5	M 6	M 8	11,6	3,8	1	8	16
10	M 4	M 5	M 6	M 8	14	3,8	1,5	12	20

1

2

Form S

n	d				b	h ₁	h ₂	Länge l
6	M 4	M 5	M 6	-	9,6	3	1	10
8	M 4	M 5	M 6	M 8	15,8	4	2	16
10	M 4	M 5	M 6	M 8	19,5	5,5	5	20

Ausführung

Stahl
verzinkt, blau passiviert

RoHS

4

SZ

Nutensteine GN 50b befestigen Anbauteile und Zubehör in der Nut von Aluprofilen.

Die Feder der Form F sichert den Nutenstein gegen unerwünschtes Verrutschen in der Nut und erleichtert so die Montage.

Nutensteine der Formen V und F sind an beliebiger Stelle in die Nut einschwenkbar.

Hinweise

GN 10b Aluprofile (Profiltyp leicht)

GN 10b Aluprofile (Profiltyp schwer)

Seite

QVX

QVX

Bestellbeispiel

GN 50b-10 M8-V-SZ

1	n
2	d
3	Form
4	Werkstoff / Oberfläche



Montagehinweis

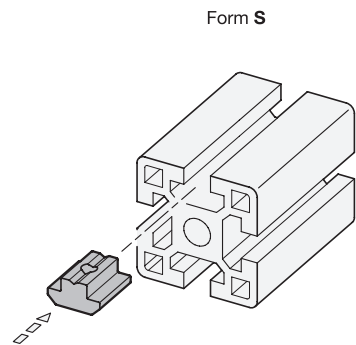
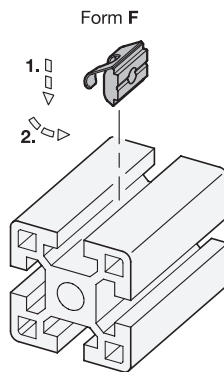
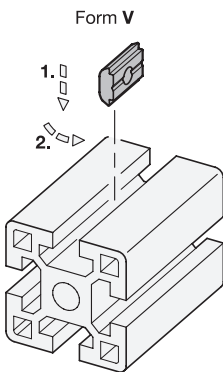

3.1
3.2
3.3
3.4
3.5
3.6
3.7
3.8
3.9
3.10

